

860 MHz Optical Receiver Integrated Circuit

FEATURES

- ◆Excellent linearity
- ◆Excellent distortion performance
- ◆Low input noise
- ◆Optical-AGC
- ◆Interchangeable package with SOT115U

PINNING - SOT115U

PIN	DESCRIPTION
1	current monitor
2	common
3	common
5	+V _B of the amplifier
7	common
8	common
9	output

DESCRIPTION

The supply voltage of KB890B0/AGC-12 is 12VDC .The module is in a package interchangeable for SOT115U(see Fig.1), has a FC/APC or SC/APC Connector, with a single mode optical input suitable for 1100 to 1650nm wavelengths , a terminal to monitor the photo diode current and an electrical output having a characteristic impedance of 75Ω . Optical power receiving at -15 ~ +2dBm , RF output is 90dBuV/Ch with optical-AGC.

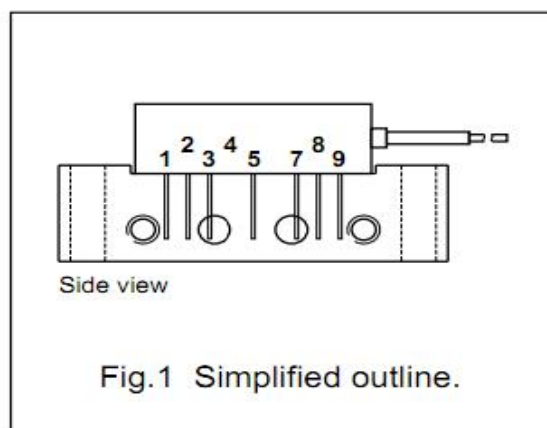

HANDLING

Fiberglass optical coupling :
 maximum tensile strength= 5 N ;
 minimum bending radius=35mm.

PHOTODIODE CURRENT MONITOR PIN

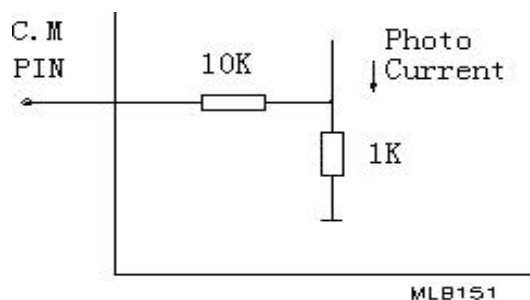

CURRENT MONITOR PIN

860 MHz Optical Receiver Integrated Circuit

LIMITING VALUES

In accordance With the Absolute Maximum Rating System

SYMBOL	PARAMETER	CONDITION	MIN	MAX	UNITS
P_{in}	Input Optical Power			3	mw
T_{stg}	Storage temperature		-40	+85	°C
T_c	Operating temperature		-20	+85	°C
ESD	ESD sensitivity	Human body model; R=1.5KΩ ;C=100pF	500		V

CHARACTERISTICS

T_{mb}=25°C, V_B=12VDC, Z_s=Z_L=75 Ω

SYMBOL	PARAMETER	UNIT	MIN.	TYP.	MAX.	CONDITIONS
f	Frequency range	MHz	40		860	
S_λ	Spectral sensitivity	A/W	0.85			λ=1310±20nm
		A/W	0.9			λ=1550±20nm
λ	Optical wavelength	nm	1100		1650	-
V_{c.m}	Voltage of C.M Pin	mV	850			λ=1310nm , 0dBm input
V_o	Output voltage	dBμV		90		Optical power receiving at -8~+2dBm, M=3.7%, Reference value @543.25MHz
FL	Flatness of frequency response	dB	-	-	±0.75	f=40 to 860MHz
CTB	Composite Triple Beat	dB	-	-70	-	60 channels flat, m=3.7%, measured at 543.25MHz;
CSO	Composite Second Order distortion	dB	-	-61	-	Optical power receiving at -8~+2dBm
C/N	Carrier to Noise Ratio	dB	-	51	-	Optical power receiving at 0dBm
S₂₂	Output Return losses	dB	-	-	-14	f=40 to 700 MHz
			-	-	-14	f=700 to 860 MHz
	Optical input return losses	dB	-	-	-45	
I_{tot}	Total Current Consumption	mA	130	160	190	V _B =12V

860 MHz Optical Receiver Integrated Circuit

PACKAGE OUTLINE

Rectangular single-ended package; aluminium flange; 2 vertical mounting holes; 2 x 6-32 UNC and 2 extra horizontal mounting holes; 7 gold-plated in-line leads; optical input;

SOT115U

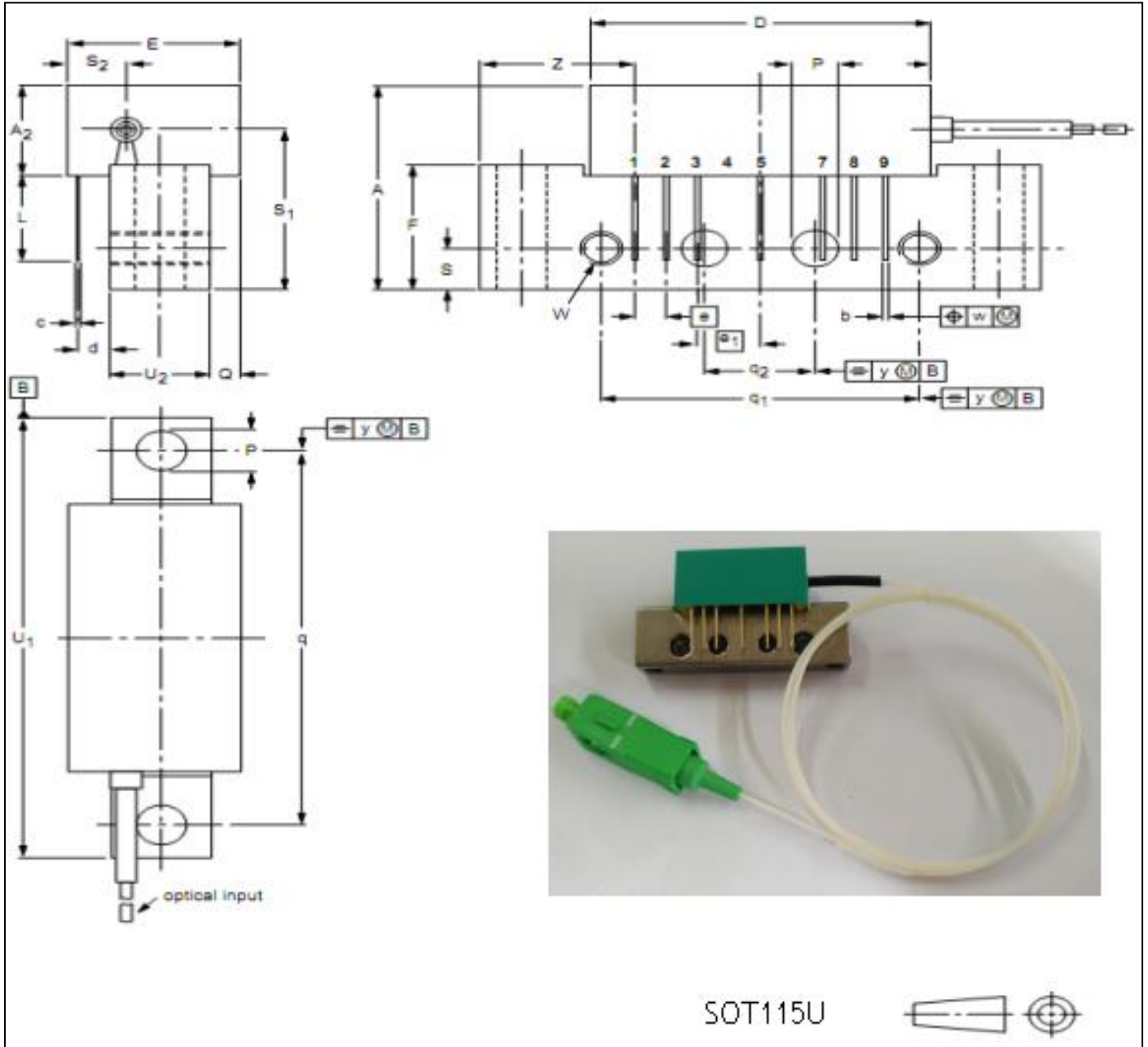

DIMENSIONS (mm are the original dimensions)

UNIT	A max.	A ₂ max.	b	c	D max.	d max.	E max.	e	e ₁	F	L min.	∅P	Q max.	q	q ₁	q ₂	S	S ₁	S ₂	U ₁ max.	U ₂	W	w	y	Z max.
mm	23.5	12	0.51 0.38	0.25	29.0	2.54	16	2.54	5.08	12.7	8.0	4.15 3.85	2.4	38.1	25.4	10.2	4.2	20	5.0	44.75	8	6-32 UNC	0.25	0.1	12

UNIT: mm